

Lumiko

Onderdeel van klemko® elektrotechniek

PRODUCT DATA SHEET

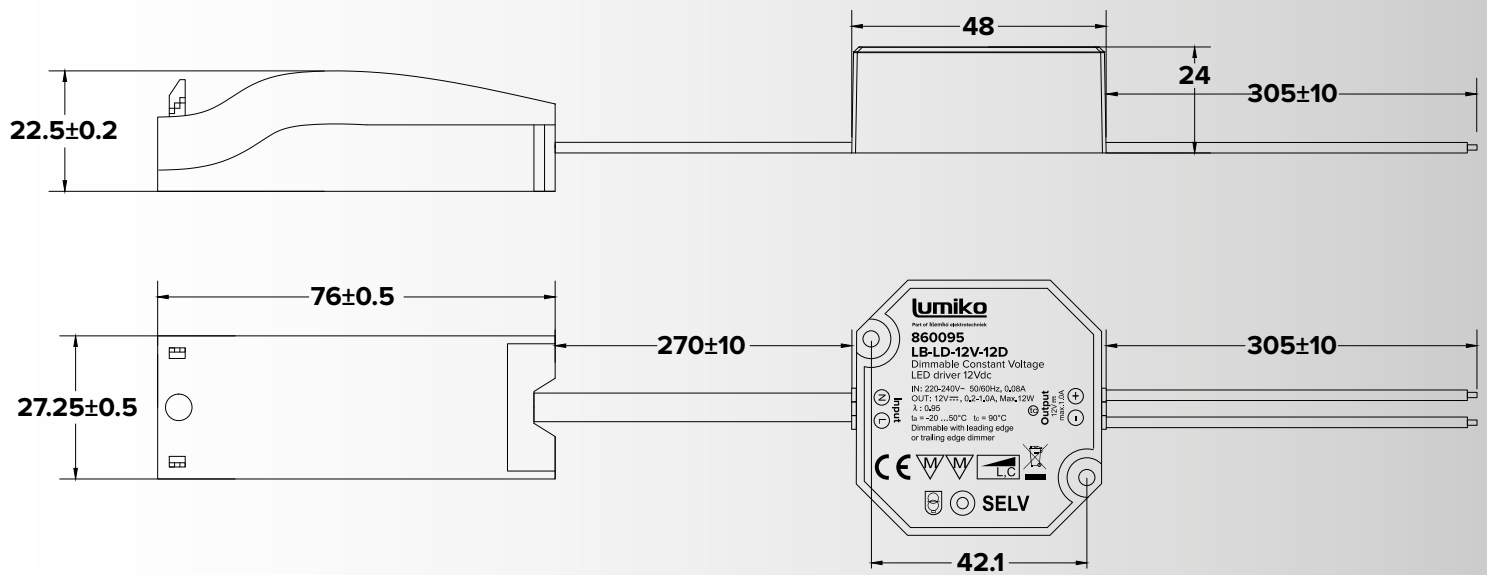

860095 LB-LD-12V-12D

FEATURES

- COMPACT DESIGN
- CONSTANT VOLTAGE DIMMABLE DRIVER
- LEADING AND TRAILING EDGE DIMMABLE
- INCL. TB-01 CONNECTION BOX

Electrical Specifications

Type		Unit	
INPUT	Nominal voltage	V	220 – 240
	Nominal frequency	Hz	50 / 60
	AC voltage range	V	198 – 264
	DC voltage range	V	176 – 250
	Nominal current	A	0.08
	THD (Full load)	%	≤ 25
	Power factor(Full load)		0.95
	Efficiency(Full load)	%	77
	Turn on time	ms	≤ 500
	No load	W	N/A
	Protection class		N/A
	Inrush current(Cold start)	A pk	5 (th = 100 μs)
	Max.units per circuit breaker		B10:125 B13:162 B16:200 B20:250 C10:125 C13:162 C16:200 C20:250
	OUTPUT	Nominal voltage range	V
Maximum voltage(Open Circuit)		Vdc	≤ 16
Output current range		A	0.2 – 1
Voltage accuracy		%	+/- 5
Ripple & noise		mV	≤ 3600
Pst LM			≤ 1
SVM			≤ 0.9
Nominal power range		W	2.4 – 12
Maximum power		W	12
Galvanic isolation			SELV
ENVIRONMENT	Ambient temperature range ta	°C	-20 ...+50
	Maximum case temperature tc	°C	90
	Max. Case temp. In fault condition	°C	110
	Storage temperature range	°C	-20 ...+70
	Relative humidity	%	5 ... 85(Not condensing)
	Surge transient protection	kV	0.5 (L/N acc to. EN 61547 Clause 5.7)
	Environmental rating		Indoor / Outdoor
	IP rating		IP65 (Driver) / IP 20 (Connection box)
	Mains switching cycles		> 100,000
	Expected lifetime	h	50,000 (0.2% / 1'000 h failure rate)
PROTECTIONS	Over temperature		Yes
	Over load		Yes
	No load		Yes
	Short-circuit		Yes
	Input overvoltage		Maximum allowed input voltage 264V AC
	Output overvoltage		Yes
Certifications			CE
	Standards		EN 61347-1, EN 61347-2-13, EN 62384, EN 55015, EN 61000-3-2, EN 61000-3-3, EN 61547, EN 60598-1, IEE1789, (EU) 2019/2020

*All parameters **NOT** specially mentioned are measured at 230VAC inputy, rated current and 25 °C of ambient temperature

OUTPUT LOAD vs A.TEMPERATURE

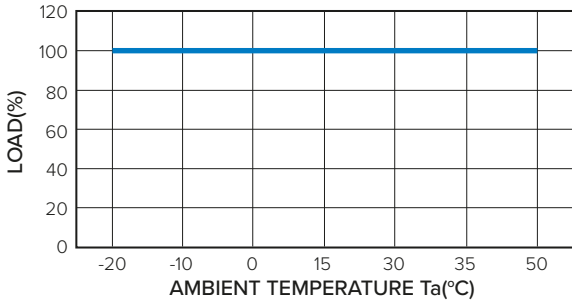

OUTPUT LOAD vs C.TEMPERATURE

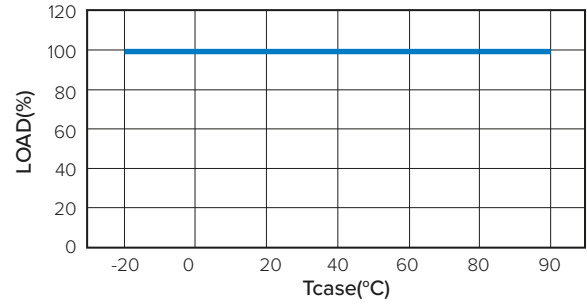

STATIC CHARACTERISTIC

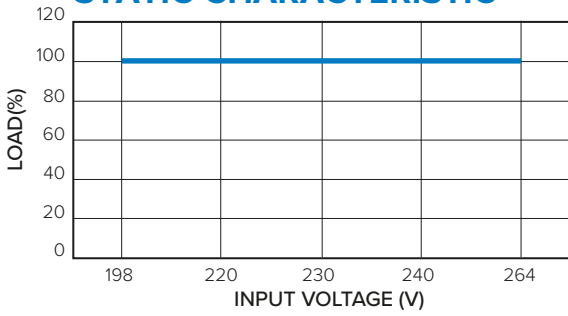

POWERFACTOR (PF) CHARACTERISTIC

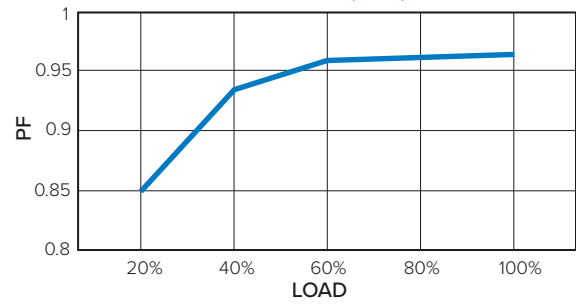

TOTAL HARMONIC DISTORTION (THD)

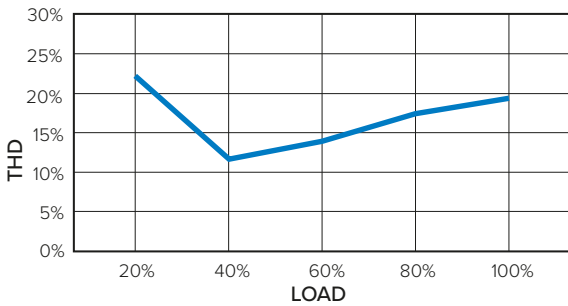

EFFICIENCY vs LOAD

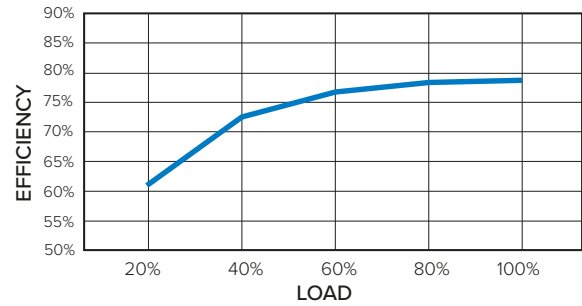

LIFE TIME

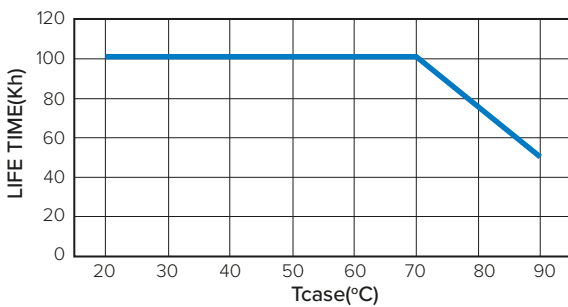

Warranty: 24 months after production date, provided that the product has been applied in accordance with requirement and has not been opened.

Klemko Techniek B.V.
Nieuwegracht 26, NL-3763 LB Soest
The Netherlands
T +31 (0)88 002 3300
info@klemko.nl
www.klemko.nl